

## MAL209624122E3

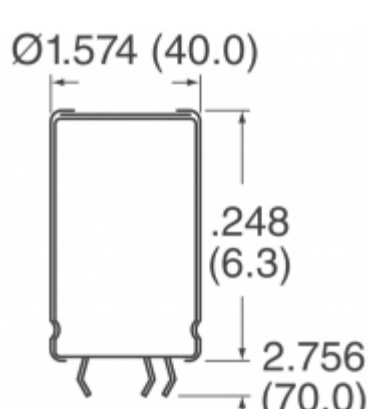

Obrázky jsou pouze orientační.  
Podrobné informace o produktu naleznete v části Technické údaje produktu.  
Koupit MAL209624122E3 s důvěrou od Component-World.HK, 1 rok záruka



**Part Number:** MAL209624122E3  
**Výrobce:** Electro-Films (EFI) / Vishay  
**Popis:** CAP ALUM 1200UF 20% 420V SNAP  
**Datový list:** [096 PLL-4TSI \(MAL2096\) Series](#)  
[Aluminum Electrolytic Capacitors Guide](#)

**RoHS Status:** Bez olova / V souladu RoHS  
**Ship From:** Hong Kong  
**Shipment Way:** DHL/Fedex/TNT/UPS/EMS









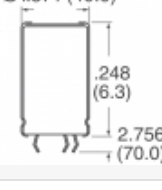
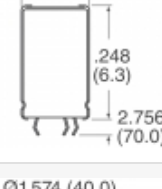
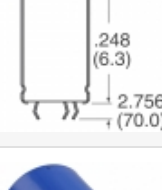

[Request For Quotation](#)

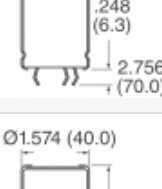
### PARAMETR PRODUKTU

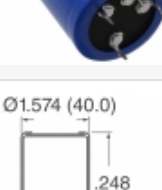
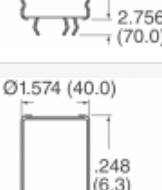
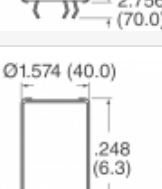
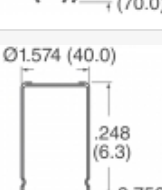
|   |                                |   |  |
|---|--------------------------------|---|--|
| <b>Part Number</b>                        | MAL209624122E3                 | <b>Výrobce</b>                            | <a href="#">Electro-Films (EFI) / Vishay</a>   |
| <b>Popis</b>                              | CAP ALUM 1200UF 20% 420V SNAP  | <b>Stav volného vedení / RoHS</b>         | Bez olova / V souladu RoHS   |
| <b>Dostupné množství</b>                  | 5244 pcs                       | <b>Datový list</b>                        | <a href="#">096 PLL-4TSI (MAL2096) Series</a><br><a href="#">Aluminum Electrolytic Capacitors Guide</a>      |
| <b>Kategorie</b>                          | <a href="#">Kondenzátory</a>   | <b>Napětí - Jmenovitá</b>                 | 420V   |
| <b>Tolerance</b>                          | ±20%                           | <b>Povrchová montáž Land Velikost</b>     | -  |
| <b>Velikost / Rozměry</b>                 | 1.575" Dia (40.00mm)           | <b>Série</b>                              | 096 PLL-4TSI   |
| <b>Ripple Current @ Low Frequency</b>     | 5.7A @ 100Hz                   | <b>hodnocení</b>                          | -  |
| <b>Polarizace</b>                         | Polar                          | <b>Obal</b>                               | Tape & Box (TB)  |
| <b>Paket / krabice</b>                    | Radial, Can - Snap-In - 4 Lead | <b>Provozní teplota</b>                   | -40°C ~ 85°C   |
| <b>Typ montáže</b>                        | Through Hole                   | <b>Úroveň citlivosti na vlhkost (MSL)</b> | 1 (Unlimited)  |
| <b>Výrobní standardní doba výroby</b>     | 21 Weeks                       | <b>Životnost @ Temp.</b>                  | 5000 Hrs @ 85°C  |
| <b>Rozestup vývodů</b>                    | 0.886" (22.50mm)               | <b>Stav volného vedení / RoHS</b>         | Lead free / RoHS Compliant   |
| <b>Impedance</b>                          | 54 mOhms                       | <b>Výška - Sedící (Max)</b>               | 1.969" (50.00mm)   |
| <b>ESR (Equivalent Resistance Series)</b> | 216 mOhm @ 100Hz               | <b>Detailní popis</b>                     | 1200µF 420V Aluminum Electrolytic Capacitors Radial, Can - Snap-In - 4 Lead 216 mOhm @ 100Hz 5000 Hrs @ 85°C |
| <b>kapacitní</b>                          | 1200µF                         | <b>Aplikace</b>                           | General Purpose  |

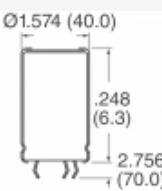
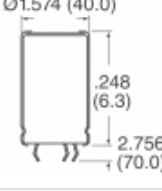
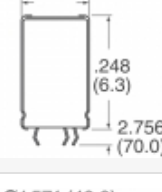
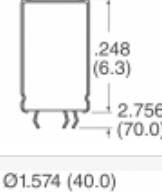
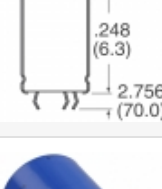
Component-World.com je spolehlivý distributor elektronických součástek. Specializujeme se na všechny elektronické komponenty řady Electro-Films (EFI) / Vishay. Máme 5244 kusy Electro-Films (EFI) / Vishay MAL209624122E3 na skladě dostupných. Vyžádejte si citát z distributora součástí elektroniky na Component-World.com, náš prodejní tým vás bude kontaktovat do 24 hodin.  
RFQ Email: [info@Components-World.com](mailto:info@Components-World.com)

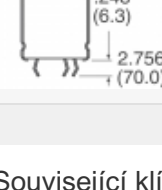
### SOUVISEJÍCÍ PRODUKTY

|  |   |  |                       |
|--|---|--|-----------------------|
|  | <b>Část#:</b> MAL209619391E3<br><b>Popis:</b> CAP ALUM 390UF 20% 500V SNAP  | <b>Výrobci:</b> <a href="#">Electro-Films (EFI) / Vishay</a> | <a href="#">Dotaz</a> |
|  | <b>Část#:</b> MAL209618681E3<br><b>Popis:</b> CAP ALUM 680UF 20% 385V SNAP  | <b>Výrobci:</b> <a href="#">Electro-Films (EFI) / Vishay</a> | <a href="#">Dotaz</a> |
|  | <b>Část#:</b> MAL209625152E3<br><b>Popis:</b> CAP ALUM 1500UF 20% 350V SNAP | <b>Výrobci:</b> <a href="#">Electro-Films (EFI) / Vishay</a> | <a href="#">Dotaz</a> |
|  | <b>Část#:</b> MAL209625182E3<br><b>Popis:</b> CAP ALUM 1800UF 20% 350V SNAP | <b>Výrobci:</b> <a href="#">Electro-Films (EFI) / Vishay</a> | <a href="#">Dotaz</a> |
|  | <b>Část#:</b> MAL209619821E3<br><b>Popis:</b> CAP ALUM 820UF 20% 500V SNAP  | <b>Výrobci:</b> <a href="#">Electro-Films (EFI) / Vishay</a> | <a href="#">Dotaz</a> |
|  | <b>Část#:</b> MAL209625222E3<br><b>Popis:</b> CAP ALUM 2200UF 20% 350V SNAP | <b>Výrobci:</b> <a href="#">Electro-Films (EFI) / Vishay</a> | <a href="#">Dotaz</a> |
|  | <b>Část#:</b> MAL209625122E3<br><b>Popis:</b> CAP ALUM 1200UF 20% 350V SNAP | <b>Výrobci:</b> <a href="#">Electro-Films (EFI) / Vishay</a> | <a href="#">Dotaz</a> |
|  | <b>Část#:</b> MAL209619561E3<br><b>Popis:</b> CAP ALUM 560UF 20% 500V SNAP  | <b>Výrobci:</b> <a href="#">Electro-Films (EFI) / Vishay</a> | <a href="#">Dotaz</a> |
|  | <b>Část#:</b> MAL209618821E3<br><b>Popis:</b> CAP ALUM 820UF 20% 385V SNAP  | <b>Výrobci:</b> <a href="#">Electro-Films (EFI) / Vishay</a> | <a href="#">Dotaz</a> |
|  | <b>Část#:</b> MAL209624821E3<br><b>Popis:</b> CAP ALUM 820UF 20% 420V SNAP  | <b>Výrobci:</b> <a href="#">Electro-Films (EFI) / Vishay</a> | <a href="#">Dotaz</a> |
|  | <b>Část#:</b> MAL209625821E3<br><b>Popis:</b> CAP ALUM 820UF 20% 350V SNAP  | <b>Výrobci:</b> <a href="#">Electro-Films (EFI) / Vishay</a> | <a href="#">Dotaz</a> |
|  | <b>Část#:</b> MAL209624182E3<br><b>Popis:</b> CAP ALUM 1800UF 20% 420V SNAP | <b>Výrobci:</b> <a href="#">Electro-Films (EFI) / Vishay</a> | <a href="#">Dotaz</a> |
|  | <b>Část#:</b> MAL209619471E3<br><b>Popis:</b> CAP ALUM 470UF 20% 500V SNAP  | <b>Výrobci:</b> <a href="#">Electro-Films (EFI) / Vishay</a> | <a href="#">Dotaz</a> |
|  | <b>Část#:</b> MAL209625102E3<br><b>Popis:</b> CAP ALUM 1000UF 20% 350V SNAP | <b>Výrobci:</b> <a href="#">Electro-Films (EFI) / Vishay</a> | <a href="#">Dotaz</a> |
|  | <b>Část#:</b> MAL209618102E3<br><b>Popis:</b> CAP ALUM 1000UF 20% 385V SNAP | <b>Výrobci:</b> <a href="#">Electro-Films (EFI) / Vishay</a> | <a href="#">Dotaz</a> |
|  | <b>Část#:</b> MAL209618122E3<br><b>Popis:</b> CAP ALUM 1200UF 20% 385V SNAP | <b>Výrobci:</b> <a href="#">Electro-Films (EFI) / Vishay</a> | <a href="#">Dotaz</a> |
|  | <b>Část#:</b> MAL209624152E3<br><b>Popis:</b> CAP ALUM 1500UF 20% 420V SNAP | <b>Výrobci:</b> <a href="#">Electro-Films (EFI) / Vishay</a> | <a href="#">Dotaz</a> |
|  | <b>Část#:</b> MAL209624681E3<br><b>Popis:</b> CAP ALUM 680UF 20% 420V SNAP  | <b>Výrobci:</b> <a href="#">Electro-Films (EFI) / Vishay</a> | <a href="#">Dotaz</a> |
|  | <b>Část#:</b> MAL209619681E3<br><b>Popis:</b> CAP ALUM 680UF 20% 500V SNAP  | <b>Výrobci:</b> <a href="#">Electro-Films (EFI) / Vishay</a> | <a href="#">Dotaz</a> |
|  | <b>Část#:</b> MAL209624102E3<br><b>Popis:</b> CAP ALUM 1000UF 20% 420V SNAP | <b>Výrobci:</b> <a href="#">Electro-Films (EFI) / Vishay</a> | <a href="#">Dotaz</a> |

### Související klíčová slova pro MAL209624122E3

|  |  |                                      |  |
|--|--|--------------------------------------|--|
| Electro-Films (EFI) / Vishay MAL209624122E3. | MAL209624122E3 distributor                   | MAL209624122E3 dodavatel             | MAL209624122E3 Cena                                    |
| MAL209624122E3 Stáhnout datasheet.           | MAL209624122E3 Datasheet.                    | MAL209624122E3 Stock.                | koupit MAL209624122E3.                                 |
| Electro-Films (EFI) / Vishay MAL209624122E3. | Electro-Films (EFI) / Vishay MAL209624122E3. | Vishay Electro-Films MAL209624122E3. | Phoenix Passive Components / Vishay<br>MAL209624122E3. |